

Sistemi Notte
EN Night Systems

PIANCA

Sistemi Notte

EN Night Systems

PIANCA

Info tecniche
EN Technical info

Struttura

EN Structure

Componenti

EN Components

Massima flessibilità per costruire uno spazio domestico riservato e personale grazie alla varietà di componenti che assicura una massima libertà progettuale, in grado di inserirsi in ogni spazio,

EN Maximum flexibility to build a personal and private space in your home, thanks to the number of modules granting a complete freedom of design, capable of fitting in every space

Basi e Cappelli

EN Bases and Tops

Le basi sono dotate di piedini regolabili, EN The bases are equipped with adjustable feet

Finiture, EN Finishes

Laccato Opaco, EN Matt Lacquered

Materico: Bianco, Borgogna, Canaletto, Rovere Laguna, Perlage Terra, Perlage Conchiglia

Tutti i componenti laccati e vetro sono personalizzabili con i colori RAL, EN All lacquered and glass componets can be lacquered in the colors of the RAL range

Fianchi, sp 3 cm

EN Sides, 1.18" th

Presentano nella parte interna un'impronta ogni 6.4 cm per il posizionamento dei ripiani spostabili,

EN On the inside there are marks for shelf support every 2.52"

Finiture esterne, EN External Finishes

Laccato Opaco o Lucido, Alaska laccato, EN Matt or High Gloss Lacquered, Alaska Lacquered

Soft Touch

Essenza, EN Wood: Borgogna, Canaletto, Rovere Fumo, Rovere Grigio, Rovere Laguna, Rovere Naturale, Rovere Tabacco

Materico: Bianco, Cenere, Seta, Alaska, Corsica

Finiture interne, EN Internal Finishes

Materico: Bianco, Borgogna, Canaletto, Rovere Laguna, Perlage Terra, Perlage Conchiglia

Laccato Opaco, EN Matt Lacquered

Fianchi di finitura

EN Finishing Sides

Finiture esterne, EN External Finishes

Laccato Opaco o Lucido, EN Matt or High Gloss Lacquered

Soft Touch

Essenza, EN Wood: Borgogna, Canaletto, Rovere Fumo, Rovere Grigio, Rovere Laguna, Rovere Naturale, Rovere Tabacco

Vetro, EN Glass: Laccato Opaco o Lucido, EN Matt or Glossy Lacquered

Metallizzato Bronzo

Specchio, EN Mirror: Argento, Fumè, Piombo

Finiture interne, EN Internal Finishes

Materico: Bianco, Borgogna, Canaletto, Rovere Laguna, Perlage Terra, Perlage Conchiglia

Laccato Opaco, EN Matt Lacquered

Divisori

EN Partitions

Per battente e scorrevole sp 2.2 cm, per complanare sp 4.5 cm. Per cabina soffietto sp 2.2 e 5 cm. Presentano nella parte interna un'impronta ogni 6.4 cm per il posizionamento dei ripiani spostabili,

EN For hinged and sliding doors 0.86"th, for flush sliding door 1.77" th Folding door dressing closets 0.86"and 1.97"th on both sides there are marks for shelf support every 2.52"

Finiture, EN Finishes

Materico: Bianco, Borgogna, Canaletto, Rovere Laguna, Perlage Terra, Perlage Conchiglia

Laccato Opaco, EN Matt Lacquered

Schienali

EN Backs

Finiture

Materico: Bianco, Borgogna, Canaletto, Rovere Laguna, Perlage Terra, Perlage Conchiglia

Materico Marmo opaco o lucido, EN Marble materico Matt or Glossy: Gioia di Carrara, Emperador, Grafite

Laccato Opaco, EN Matt Lacquered

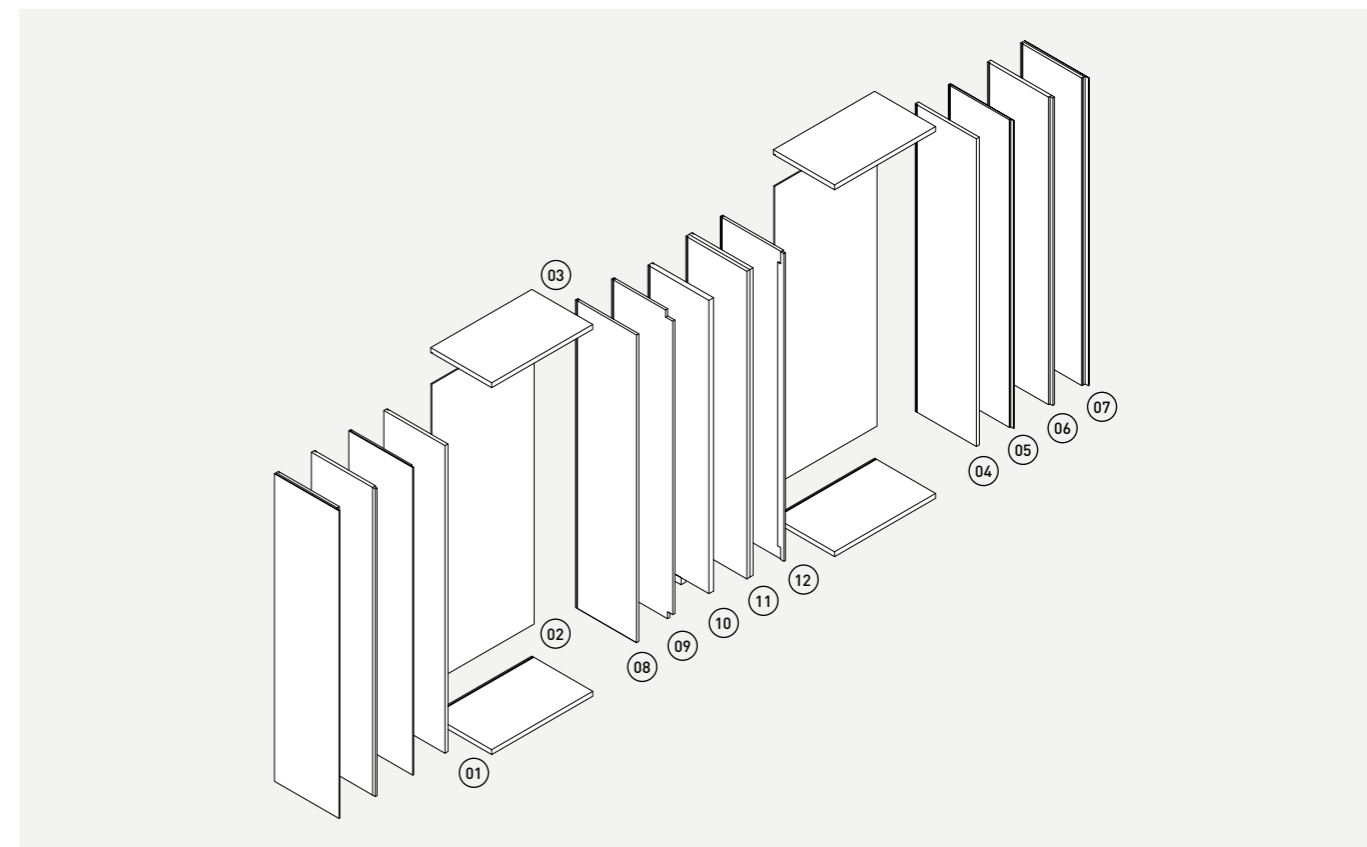

Nomenclatura

EN Nomenclature

01
Base sp 4 cm,
EN Base 1.57" th

02
Schienale sp 0.8 cm,
EN Back panel 0.31" th

03
Cappello sp 4 cm,
EN Top 1.57" th

04
Fianco legno sp 3 cm,
EN Wooden side 1.18" th

05
Fianco di finitura
battente sp 1.9 cm,
EN Finishing side for
hinged door 0.75" th

06
Fianco legno cornice
per battente sp 3 cm,
EN Wooden side frame
for hinged door 1.18" th

07
Fianco di finitura per
scorrevole o complanare
sp 3.9 cm,
EN Finishing side for sliding
or flush sliding door 1.54" th

Divisori interni

EN Internal partiotions

08
Battente sp 2.2 cm,
EN Hinged door 0.87" th

09
Scorrevole sp 2.2 cm,
EN Sliding door 0.87" th

10
Complanare sp 4.5 cm,
EN Flush sliding door
1.77" th

11
Scorrevole 4 ante sp 3+3 cm,
EN 4 Sliding door wardrobe
1.30"+ 1.30"th

12
Con cornice per unione
battente e scorrevole sp
2.2 cm,
EN With frame for
connection with hinged
and sliding door modules
0.87" th

Finiture interne

^{EN} Internal finishes



Materico Bianco



Laccato Opaco nei colori della collezione
^{EN} Matt Lacquered in all the colors of our collection



Perlage Conchiglia



Perlage Terra



Materico Canaletto



Materico Borgogna



Materico Rovere Laguna

Tutte le finiture interne sono applicabili a: Base, Cappello, Ripiani, Interno Fianchi, Schienali e Divisori. ^{EN} All internal finishes are available for: Base, Top, Shelves, Internal Sides, Backs and Partitions.

Complementi cabine
EN Walk-in closet complements

Vista sistema di chiusura

EN Vista door system

Il sistema di chiusura Vista si caratterizza per la totale assenza di telai e per la modularità al millimetro. Binari e ante vengono sempre realizzati su misura,

EN A characteristic of the Vista door system is the absence of frames and the extremely wide modularity. Rails and doors are always made to measure

Binario monorotaia

EN Single track

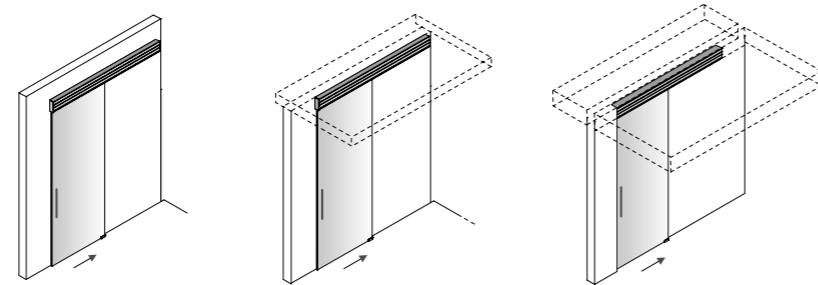

A parete,

EN Wall mounted

L min 135 max 600 cm
W min 53.15" max 236.22"

A soffitto,

EN Ceiling mounted

L min 135 max 600 cm
W min 53.15" max 236.22"

Ad incasso,

EN Recessed

L min 135 max 600 cm
W min 53.15" max 236.22"

Binario monorotaia + pannello fisso

EN Single track + fixed panel

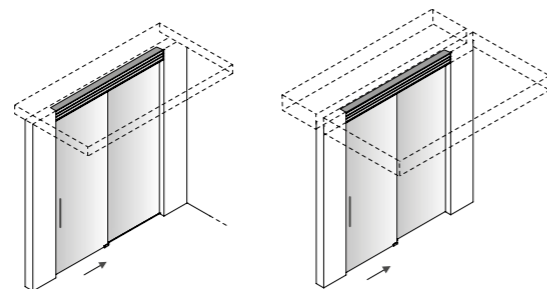

A soffitto,

EN Ceiling mounted

L min 138 max 600 cm
W min 54.33" max 236.22"

Ad incasso,

EN Recessed

L min 138 max 600 cm
W min 54.33" max 236.22"

Binario birotaia

EN Double track

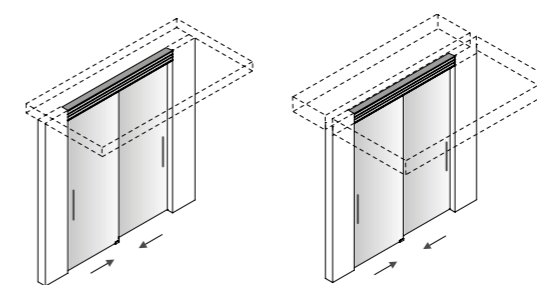

A soffitto,

EN Ceiling mounted

L min 138 max 600 cm
W min 54.33" max 236.22"

Ad incasso,

EN Recessed

L min 138 max 600 cm
W min 54.33" max 236.22"

Pannelli fissi divisori

EN Fixed panels dividers

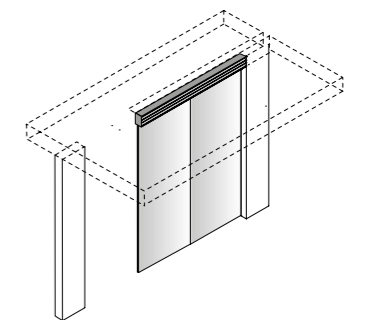

Pannello fisso divisorio,

EN Fixed panel divider

L min 70 max 600 cm
W min 27.56" max 236.22"

Angolari

EN Corner

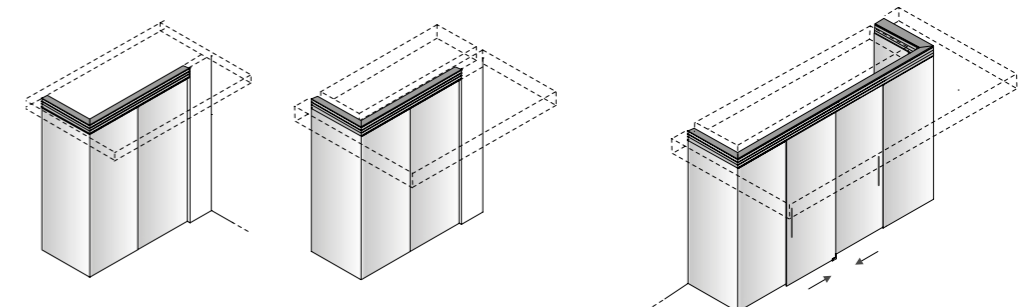

Pannello fisso soffitto,

EN Ceiling mounted fixed panel

L min 70 max 600 cm
W min 27.56" max 236.22"

Pannello fisso ad incasso,

EN Recessed fixed panel

L min 70 max 600 cm
W min 27.56" max 236.22"

2 pannelli fissi e 2 ante su binario birotaia a soffitto,

EN 2 fixed panels and 2 doors on recessed double track

L min 70 max 600 cm
W min 27.56" max 236.22"

Vista con anta Crystal

EN Vista with Crystal door

Finiture EN Finishes

Finiture anta, EN Door finishes

Vetro, ^{EN} Glass:
Laccato Opaco o Lucido,
^{EN} Matt or Glossy
Lacquered

Fumé Trasparente,
Trama Argento, Trama
Bronzo, Trama Fumé

Finiture Binario, EN Track Finishes

Alluminio Anodizzato o
pitturabile con tempere
murarie, ^{EN} Anodised or
paintable aluminum

Maniglie EN Handles

Con Gola, ^{EN} With groove
U40

Finiture Metallo,
^{EN} Metal Finishes:
Bronzo, Cromo, Oro,
Rame, Titanio

Laccato Opaco,
^{EN} Matt Lacquered



Modularità EN Modularity

L da 70 a 120 cm
H da 190 a 280 cm

W from 27.56" to 47.24"
H from 74.80" to 110.24"

Pannello fisso, EN Fixed panel

L da 70 a 120 cm
H da 190 a 280 cm

W from 27.56" to 47.24"
H from 74.80" to 110.24"

Binario di scorrimento, EN Track

L max 600 cm
W max 236.22"

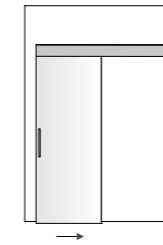

Anta scorrevole con binario a parete, EN Sliding door with wall mounted track

Dimensione vano,
^{EN} Opening:

L da 68 a 118 cm
H da 186 a 276 cm

W from 26.77" to 46.46"
H from 73.22" to 108.66"

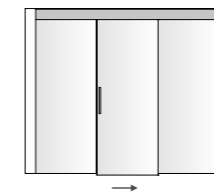

Anta scorrevole e 2 pannelli fissi binario a soffitto, ^{EN} Door and 2 fixed panels on a ceiling mounted track

Dimensione vano,
^{EN} Opening:

L da 206 a 356 cm
H da 199 a 289 cm

W from 81.10" to 140.16"
H from 78.35" to 113.78"

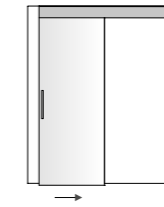

Anta scorrevole con binario a soffitto, EN Sliding door with ceiling mounted track

Dimensione vano,
^{EN} Opening:

L da 68 a 118 cm
H da 199 a 289 cm

W from 26.77" to 46.46"
H from 78.35" to 113.78"

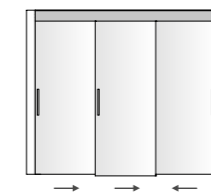

3 ante scorrevoli con binario a soffitto, EN 3 sliding doors with ceiling mounted track

Dimensione vano,
^{EN} Opening:

L da 206 a 356 cm
H da 199 a 289 cm

W from 81.10" to 140.16"
H from 78.35" to 113.78"

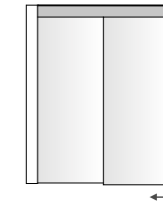

Anta scorrevole e pannello fisso con binario a soffitto, EN Door and fixed panel on ceiling mounted track

Dimensione vano,
^{EN} Opening:

L da 138 a 238 cm
H da 199 a 289 cm

W from 54.33" to 93.70"
H from 78.35" to 113.78"

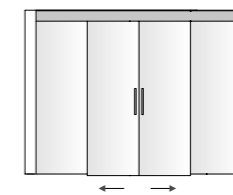

2 ante scorrevoli e 2 pannelli fissi binario a soffitto, ^{EN} 2 sliding doors and 2 fixed panels on a ceiling mounted track

Dimensione vano,
^{EN} Opening:

L da 276 a 476 cm
H da 199 a 289 cm

W from 108.66" to 187.40"
H from 78.35" to 113.78"

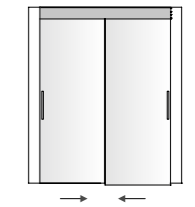

2 ante scorrevoli con binario a soffitto, EN 2 sliding doors with ceiling mounted track

Dimensione vano,
^{EN} Opening:

L da 138 a 238 cm
H da 199 a 289 cm

W from 54.33" to 93.70"
H from 78.35" to 113.78"

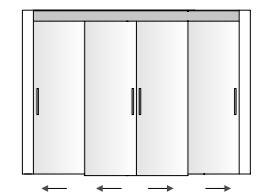

4 ante scorrevoli binario a soffitto, EN 4 sliding doors on a ceiling mounted track

Dimensione vano,
^{EN} Opening:

L da 276 a 476 cm
H da 199 a 289 cm

W from 108.66" to 187.40"
H from 78.35" to 113.78"

Vista con anta Plana

EN Vista with Plana door

Finiture EN Finishes

Finiture anta, EN Door finishes

Laccato Opaco o Lucido,
Alaska Laccato, EN Matt
or High Gloss Lacquered,
Alaska Lacquered

Soft touch

Essenza, EN Wood:
Borgogna, Canaletto,
Rovere Fumo, Rovere
Grigio, Rovere Laguna
Rovere Naturale, Rovere
Tabacco

Materico: Bianco, Cenere,
Seta, Alaska, Corsica

Pitturabile con tempere
murarie, EN Paintable

Finiture Binario, EN Track Finishes

Alluminio Anodizzato o
pitturabile con tempere
murarie, EN Anodised
aluminum, paintable
aluminum

Maniglie EN Handles

U40

Finiture Metallo,
EN Metal Finishes:
Bronzo, Cromo, Oro,
Rame, Titanio

Laccato Opaco,
EN Matt Lacquered



Modularità EN Modularity

L da 70 a 120 cm
H da 190 a 280 cm

W from 27.56" to 47.24"
H from 74.80" to 110.24"

Pannello fisso, EN Fixed panel

L da 70 a 120 cm
H da 190 a 280 cm

W from 27.56" to 47.24"
H from 74.80" to 110.24"

Binario di scorrimento, EN Track

L max 600 cm
W max 236.22"

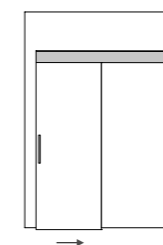

Anta scorrevole con binario a parete, EN Sliding door with wall mounted track

Dimensione vano,
EN Opening:

L da 68 a 118 cm
H da 186 a 276 cm

W from 26.77" to 46.46"
H from 73.22" to 108.66"

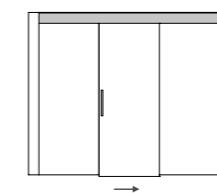

3 ante scorrevoli con binario a soffitto, EN 3 sliding doors with ceiling mounted track

Dimensione vano,
EN Opening:

L da 206 a 356 cm
H da 199 a 289 cm

W from 81.10" to 140.16"
H from 78.35" to 113.78"

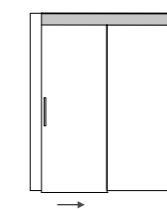

Anta scorrevole con binario a soffitto, EN Sliding door with ceiling mounted track

Dimensione vano,
EN Opening:

L da 68 a 118 cm
H da 199 a 289 cm

W from 26.77" to 46.46"
H from 78.35" to 113.78"

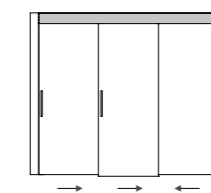

Anta scorrevole e 2 pannelli fissi binario a soffitto, EN Sliding doors and 2 fixed panels on a ceiling mounted track

Dimensione vano,
EN Opening:

L da 206 a 356 cm
H da 199 a 289 cm

W from 81.10" to 140.16"
H from 78.35" to 113.78"

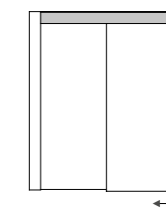

Anta scorrevole e pannello fisso con binario a soffitto, EN Sliding door and fixed panel on ceiling mounted track

Dimensione vano,
EN Opening:

L da 138 a 238 cm
H da 199 a 289 cm

W from 54.33" to 93.70"
H from 78.35" to 113.78"

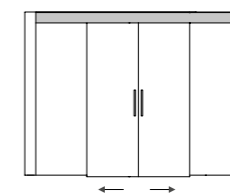

2 ante scorrevoli e 2 pannelli fissi binario a soffitto, EN 2 sliding doors and 2 fixed panels on a ceiling mounted track

Dimensione vano,
EN Opening:

L da 276 a 476 cm
H da 199 a 289 cm

W from 108.66" to 187.40"
H from 78.35" to 113.78"

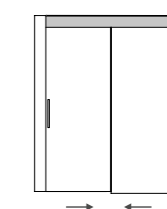

2 ante scorrevoli con binario a soffitto, EN 2 sliding doors with ceiling mounted track

Dimensione vano,
EN Opening:

L da 138 a 238 cm
H da 199 a 289 cm

W from 54.33" to 93.70"
H from 78.35" to 113.78"

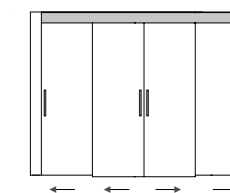

4 ante scorrevoli binario a soffitto, EN 4 sliding doors on a ceiling mounted track

Dimensione vano,
EN Opening:

L da 276 a 476 cm
H da 199 a 289 cm

W from 108.66" to 187.40"
H from 78.35" to 113.78"